

New
Line Up

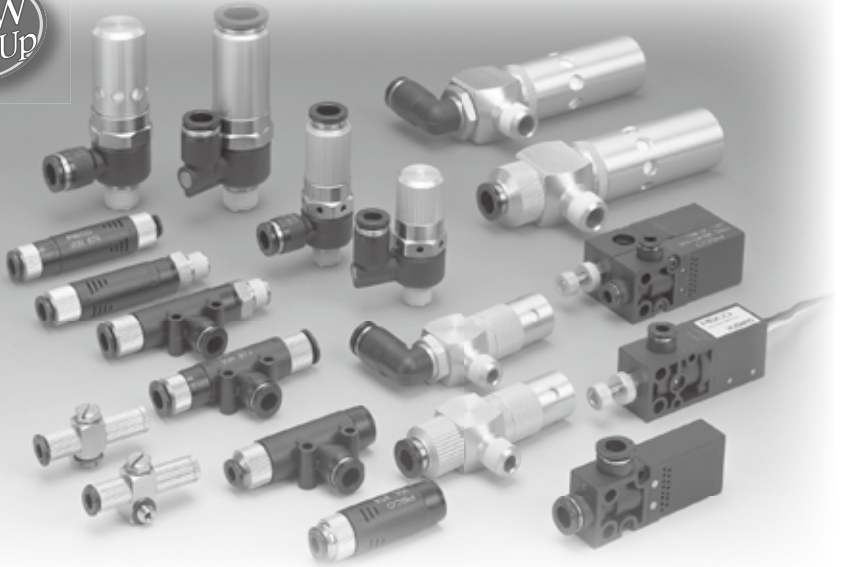

Ejector for Various Piping Conditions Vacuum Generators

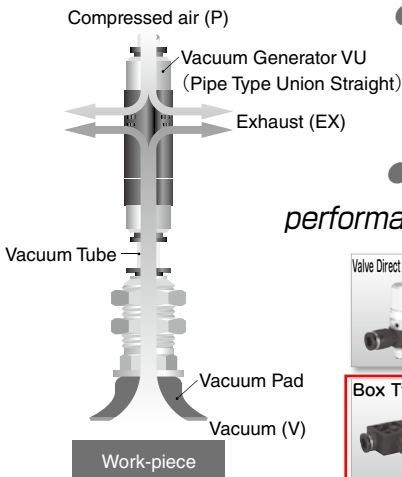

- *Creating vacuum by use of compressed air can be used in combination with a Vacuum Pad to convey materials.*

- *Vacuum Generator comes in a variety of performance and types to meet your applications.*

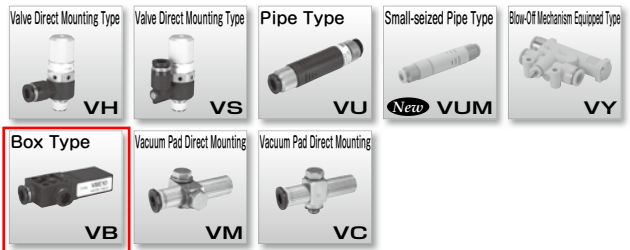

☞ *For the applications requiring copper alloy free material and countermeasures against low ozone concentration, VH, VS, VU, and VC are selectable. Metal parts material is copper alloy free. HNBR is used for seal rubber material.*

VACUUM GENERATOR
EXTERNAL VACUUM CONTROLLER
VACUUM PAD
VACUUM ACCESSORIES

52

VH VS
VU
VUM
VY
VB
VM VC
VRL
VG
VK
VJ
VX
VQ
VZ
VN



Vacuum Generator Series

Vacuum Generator VH,VS,VU,VUM,VB,VM,VC,VY

VACUUM GENERATOR

■ Characteristics

VY Type (With Blow-Off Mechanism)

● *Ejector and Blow-Off Mechanism are integrated.*

VY Type provides a high cost performance, compared to a normal solenoid valve equipped type.

● *Small and lightweight body makes it possible to place on the terminal part of the vacuum piping. High speed cycle of suction and Blow-Off Mechanism is achieved by diffuser spool.*

VUM Type (Super small pipe type)

● *Super small and lightweight ejector.*

Outer diameter : $\varnothing 8.5\text{mm}$, Weight : Max. 7.7g

● *Nozzle bore selection : $\varnothing 0.3$, $\varnothing 0.4$ and $\varnothing 0.5\text{mm}$*

VUM Type meets the demands of low air consumption.

Vacuum characteristics	Nozzle bore ($\varnothing\text{mm}$)	Rated supply pressure (MPa)	Vacuum level (-kPa)	Suction flow ($\ell/\text{min}[\text{ANR}]$)	Air consumption ($\ell/\text{min}[\text{ANR}]$)
H03	0.3	0.5	90	2	4.5
L03			66	3	
E03			88	1	
H04	0.4	0.5	90	4	8
L04			66	7	
E04			90	2	
H05	0.5	0.5	90	7	11.5
L05			66	12	
E05			90	3	

※ The above "Vacuum characteristics" codes mean as follows. "H: High-vacuum type" , "L: Large-flow type" and "E: High-vacuum at low air pressure supply type" .

● *Connectable to small Vacuum pad holder VPMB directly.*

● *Easy detachment by optional fixing holder (VUK04).*

VC, VM Type (Vacuum pad Direct Mounting)

● *Nozzle bore : $\varnothing 0.3$ and $\varnothing 0.4\text{mm}$ are available in the series (VC and VM).*

VC and VM Type meet the demands of low air consumption flow.

Vacuum characteristics	Nozzle bore ($\varnothing\text{mm}$)	Rated supply pressure (MPa)	Vacuum level (-kPa)	Suction flow ($\ell/\text{min}[\text{ANR}]$)	Air consumption ($\ell/\text{min}[\text{ANR}]$)
H03	0.3	0.5	90	2	4.5
L03			66	4	
H04			90	4	
L04	0.4	0.5	66	7.5	8

※ The above "Vacuum Characteristics" codes mean as follows. "H: High-vacuum type" , and "L: Large-flow type" .

Piping example

Pipe (VU) Type

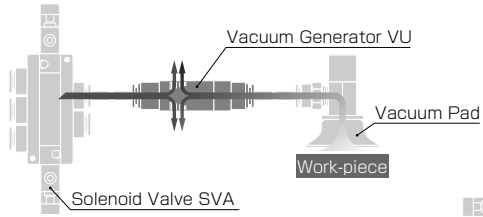

Box (VB) Type

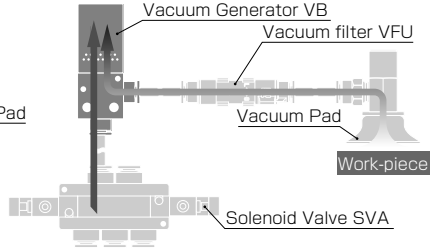

Valve Direct Mounting (VH, VS) Type

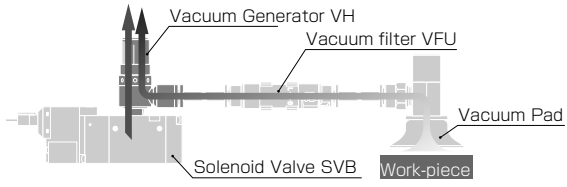

Vacuum Pad Direct Mounting (VC, VM) Type

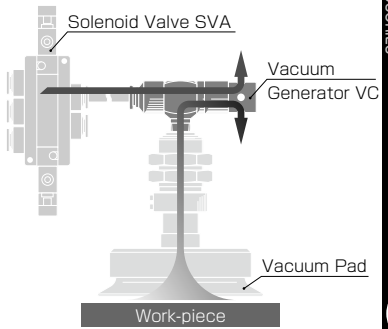

Blow-Off Mechanism Equipped (VY) Type

■ Example 1

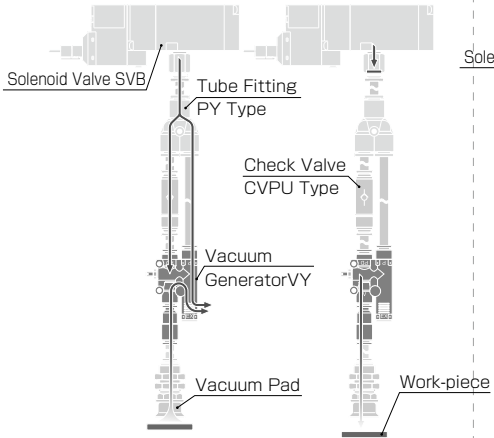

■ Example 2. Usage with Twin 3-way valve (SVA21).

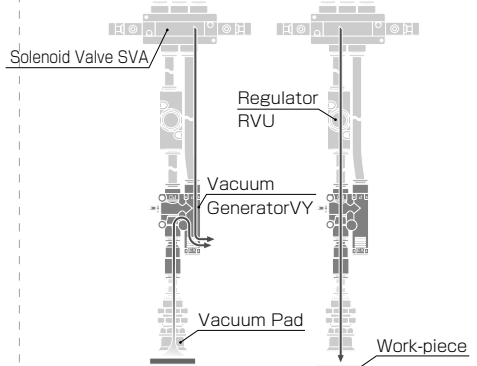

Connect P Port and PD Port with Check Valve (Purchase separately). The residual pressure between Check Valve and PD Port turns into a blow-off air. The flow rate of the blow-off air is adjusted by a release needle. Blow-off time can be controlled by the tube length between Check Valve and PD Port.

Work-piece can be released instantly by adjusting a blow-off pressure and a flow rate. But it is necessary to pay attention not to blow away the work-piece. The above figure shows an example to arrange the different pressure supplies to vacuum generation side and Blow-Off Mechanism side when a blow-off pressure needs to be controlled low (Pressure to vacuum generation side \geq Pressure to Blow-Off Mechanism side). A blow-off air is adjusted by the release needle. Blow-off time is controlled by the solenoid valve (SVA21 series).



Vacuum Generator Series

Vacuum Generator VH,VS,VU,VUM,VB,VM,VC,VY

VACUUM GENERATOR

Model Designation (Example)

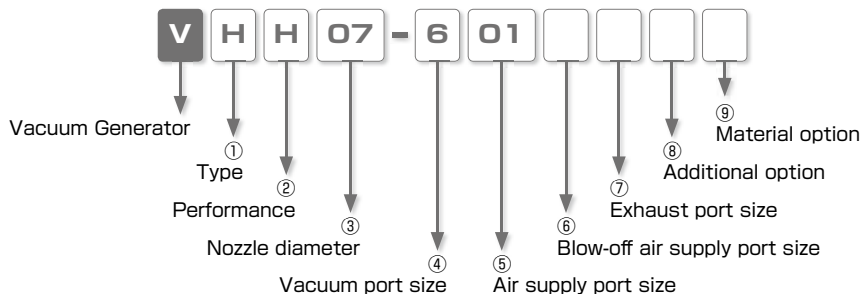

① Type

Code	Type	Code	Type	Code	Type
H	Valve Direct Mounting Type Elbow	U	Pipe Type	UM	Small-seized Pipe Type
M	Vacuum Pad Direct Mounting Type Elbow	S	Valve Direct Mounting Type Straight	B	Box Type
C	Vacuum Pad Direct Mounting Type Straight	Y	Blow-Off Mechanism Equipped Type		

② Performance

Code	Performance	Code	Performance	Code	Performance
H	High-vacuum type (Rated supply pressure : 0.5MPa)	L	Large-flow type (Rated supply pressure : 0.5MPa)	E	High-vacuum at low air pressure supply type (Rated supply pressure : 0.5MPa)

③ Nozzle bore

Code	Nozzle bore	H type		L type		E type	
		Vacuum level, Suction flow	Vacuum level, Suction flow	Vacuum level, Suction flow	Vacuum level, Suction flow	Vacuum level, Suction flow	Vacuum level, Suction flow
03	ø0.3mm	-90kPa, 2l/min[ANR]*1	-66kPa, 4l/min[ANR]*1	-88kPa, 1l/min[ANR]*1			
04	ø0.4mm	-90kPa, 4l/min[ANR]*1	VUM type : -66kPa, 7l/min[ANR]*1 VC, VM type : -66kPa, 7.5l/min[ANR]*1	-90kPa, 2l/min[ANR]*1			
05	ø0.5mm	-90kPa, 7l/min[ANR]	-66kPa, 12l/min[ANR]	-90kPa, 3l/min[ANR]*2			
07	ø0.7mm	-92 ~ -93kPa, 12.5 ~ 13l/min[ANR]	-66kPa, 22 ~ 26l/min[ANR]	-90 ~ 92kPa, 10 ~ 10.5l/min[ANR]			
10	ø1.0mm	-93kPa, 28l/min[ANR]	-66kPa, 42l/min[ANR]	-92kPa, 21l/min[ANR]			
12	ø1.2mm	-93kPa, 38l/min[ANR]	-	-92kPa, 27l/min[ANR]			
15	ø1.5mm	-93kPa, 63l/min[ANR]	-66kPa, 95l/min[ANR]	-92kPa, 42l/min[ANR]			
20	ø2.0mm	-93kPa, 104l/min[ANR]	-66kPa, 174l/min[ANR]	-92kPa, 82l/min[ANR]			

※ 1. Nozzle bore ø0.3 and 0.4mm of H, L and E type are only for VUM, VC and VM.

※ 2. Nozzle bore ø0.3 and 0.4mm of E type with is only for VUM.

※ 3. Supply pressure of H and L type is 0.5MPa and that of E type is 0.35MPa.

■ VY type

Code	Nozzle bore	H type Vacuum level, Suction flow	L type Vacuum level, Suction flow	E type Vacuum level, Suction flow
05	ø0.5mm	-90kPa, 7l/min[ANR]	-66kPa, 12l/min[ANR]	-90kPa, 3l/min[ANR]
07	ø0.7mm	-92kPa, 12.5l/min[ANR]	Tube O.D. ø4mm : -66kPa, 18l/min[ANR] Tube O.D. ø6mm : -66kPa, 21l/min[ANR]	-90kPa, 9l/min[ANR]

55

VH - VS

VU

VUM

VY

VB

VM - VC

④ Vacuum port size

Joint type	Push-In Fitting							Metric thread (mm)			Taper pipe thread		
Code	180	3	4	6	8	10	12	M3	M5	M6	01	02	03
Size	ø1.8mm	ø3mm	ø4mm	ø6mm	ø8mm	ø10mm	ø12mm	M3×0.5	M5×0.8	M6×1	R1/8	R1/4	R3/8
Type	VH, VS		○	○	○	○	○						
	VB, VY			○	○								
	VU			○	○				○	○	○		
	VUM	○	○	○				○	○				
	VC								○	○	○	○	○
	VM								○	○			

⑤ Air supply port size

Joint type	Push-In Fitting					Metric thread (mm)		Taper pipe thread			
Code	3	4	6	8	10	M5	M6	01	02	03	
Size	ø3mm	ø4mm	ø6mm	ø8mm	ø10mm	M5×0.8	M6×1	R1/8	R1/4	R3/8	
Type	VH, VS					○	○	○	○	○	
	VB, VY		○	○							
	VU		○	○							
	VUM	○	○								
	VC	○	○	6C, 6L	8C, 8L	10C, 10L					
	VM	○	○								

⑥ Blow-off air supply port size (VY only)

Code	4	6
Tube dia.	ø4mm	ø6mm

⑦ Exhaust port (VH, VS, VU, VC and VY only)

Code	No code	J
Port type	Silencer vent	Tube exhaust

⑧ Additional option (VU, VB and VY only)

Code	A	P	S	F
Additional option	Separable type (VU only)	Resin type (VB only)	With mechanical vacuum switch (VB only)	With vacuum filter (VY only)

⑨ Material option

Code	No code	-S3
Material	Standard	Copper alloy free material
Applicable types	All types	VH (Tube exhaust) VS (Tube exhaust) VU (Tube exhaust) VC (Tube exhaust)

■ Model Designation of Mechanical Vacuum Switch



Mechanical Vacuum Switch

① Pressure port (Negative pressure)

① Pressure port (Negative pressure)

Code	4	6
Tube dia.	ø4mm	ø6mm



Vacuum Generator Series

Vacuum Generator VH,VS,VU,VUM,VB,VM,VC,VY

VACUUM GENERATOR

■ Specification (Excluding VY)

Fluid medium	Air
Operating pressure range	0.15 ~ 0.7MPa
Rated pressure supply	H, L type : 0.5MPa (E type : 0.35MPa)
Operating temp. range	0 ~ 60°C (No freezing)

■ Specification of Box Union Switch Type VB and Mechanical Vacuum Switch Type VUSM

Pressure detection	Diaphragm to Micro switch
Fluid medium	Air
Operating temp. range	0 ~ 60°C (No freezing)
Micro switch rating	3A 250V
Pressure setting range	-20 ~ -66kPa
Accuracy	±5kPa
Differential response	22kPa
Factory default pressure	-53kPa
Lead wire	Length: About 300mm (White: Common, Red: Normally closed, Black: Normally open)

■ Specification of Blow-off Mechanism Equipped VY

Fluid medium	Air
Operating pressure range	0.3 ~ 0.7MPa
Rated pressure supply	H, L type : 0.5MPa (E type : 0.35MPa)
Operating temp. range	5 ~ 50°C
Lubrication	Not required

■ Specification of Vacuum Filter for VY

Fluid medium	Air
Operating pressure range	-100 ~ 0kPa
Filtering capacity	10μm
Operating temp. range	0 ~ 60°C (No freezing)
Filter area	Joint size 44 : 0.8cm ²
	Joint size 66 : 1.1cm ²
Material	PVF (Polyvinyl formal)

Construction (Valve Direct Mounting Type Elbow: VH)

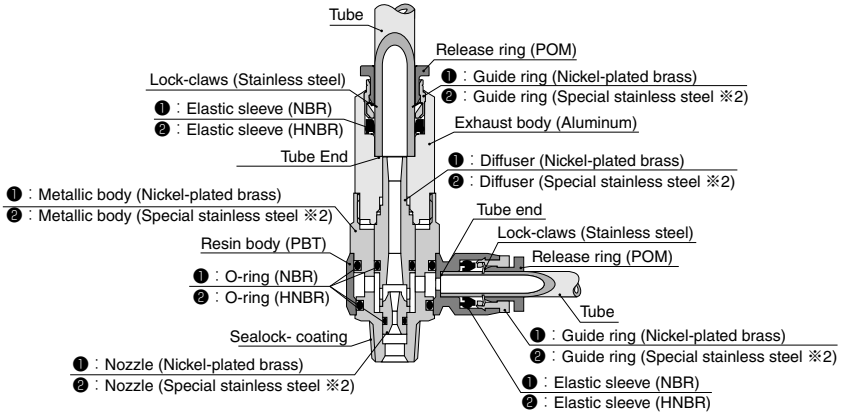

※ 1. The above ① material is for standard type. ② is for the type of copper alloy free material.
 ※ 2. Performance of corrosion resistance is equal to SUS303.

Construction (Blow-Off Mechanism Equipped Type: VY)

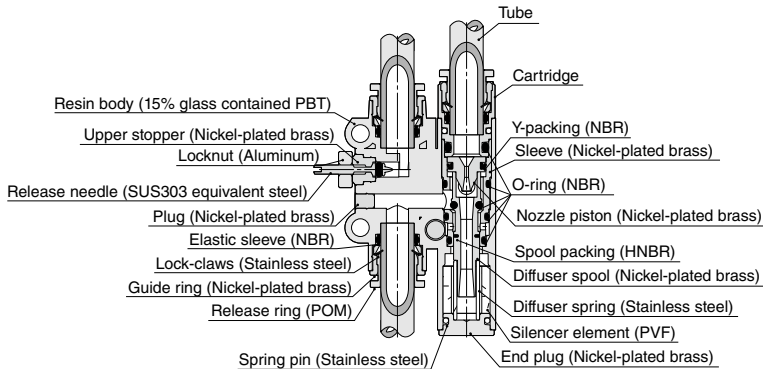

⚠ Detailed Safety Instructions

Before using PISCO products, be sure to read "Safety Instructions" and "Safety Instruction Manual" on page 35-39, "Common Safety Instructions for Vacuum Series" on page 47-49 and "Common Safety Instructions for Mechanical Vacuum Switch" on page 50.

Warning

1. For the VC type with M5×0.8, piping direction cannot be changed after installation of the body.
2. Before installing VY type, thoroughly read this instruction for piping method of VY Vacuum Generator. Wrong piping may cause injuries to human bodies and damage to equipments.
3. Resin body of VY vacuum filter is made of PP. Material deterioration may be caused by exposure to direct sunlight or ultra-violet rays.
4. Please do not apply load in a pulling direction to the generator VU and VUM. The tension loading may cause breakup of the generator.
5. Please avoid increasing unnecessary inner pressure for VU and VUM. Metal part may come away from resin unit.

Caution

1. In order to adjust blow-off air and blow-off time of VY Vacuum Generator, thoroughly read the catalog and understand the method.
2. The filter element of VY type is not replacable. When the replacement is necessary, replace the whole vacuum filter unit.
3. When applying different pressure level for vacuum generation and blow-off for VY, keep the blow-off pressure level under the level of vacuum generation. If the blow-off pressure level is higher than the level of vacuum generation, it may cause air leakage.
4. When the unit is used as following piping diagram, the blow-off air from check valve is exhausted from V port for a short period until shut-off valve is fully switched.

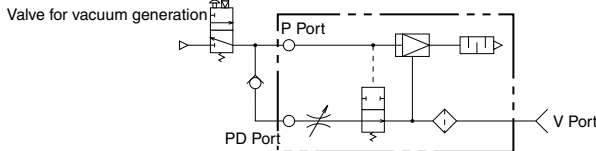

5. When connecting a tube for VY Vacuum Filter, please do not apply excessive force. It may break the inside of filter.
6. In the assembly after the maintenance of filter of VUM, confirm the plug is installed in the right position as shown in the below construction first, and then install the spacer and filter element. It is unnecessary to take out the plug at the maintenance.
7. In case of VU and VUM type, make sure to place the right part in the correct position with right method (There must not be space between the resin body and the vacuum port unit) at the filter element maintenance. Otherwise, the satisfactory product performance cannot be obtained.

● Construction of VUM

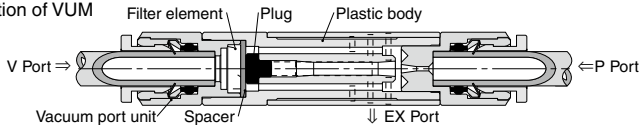

● Construction of VU

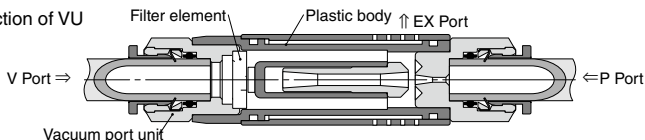

Characteristics

Supply pressure - Final vacuum / Suction Flow / Air Consumption

VACUUM GENERATOR
EXTERNAL VACUUM CONTROLLER
VACUUM PAD
ACCESSORIES

60

VH-VS

VU

VUM

VY

VB

VM-VC

VRL

VG

VK

VJ

VX

VQ

VZ

VN

VHH05, VHL05, VSH05, VSL05, VBH05, VBL05

Vacuum characteristics

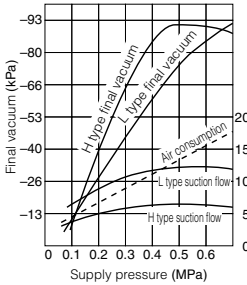

Flow characteristics

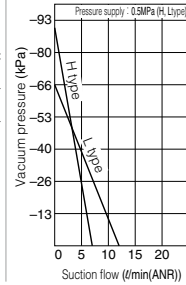

VHH07, VHL07, VEH07, VSH07, VSL07, VSE07, VBH07, VBL07, VBE07, VCH07, VCL07, VCE07

Vacuum characteristics

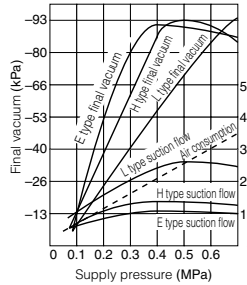

Flow characteristics

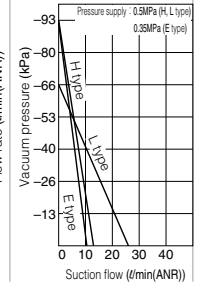

VHH10, VHL10, VEH10, VSH10, VSL10, VSE10, VBH10, VBL10, VBE10, VCH10, VCL10, VCE10

Vacuum characteristics

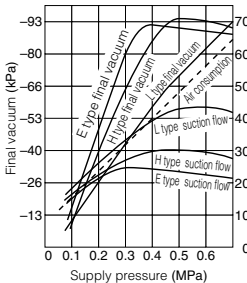

Flow characteristics

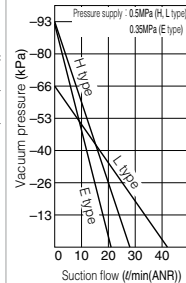

VHH12, VHE12, VSH12, VSE12, VBH12, VBE12, VCH12, VCE12

Vacuum characteristics

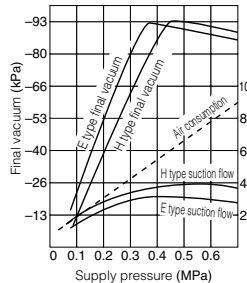

Flow characteristics

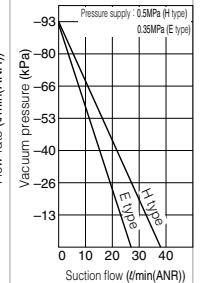

VHH15, VHL15, VHE15, VSH15, VSL15, VSE15, VCH15, VCL15, VCE15

Vacuum characteristics

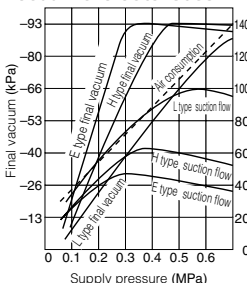

Flow characteristics

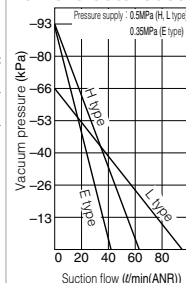

VCH20, VCL20, VCE20

Vacuum characteristics

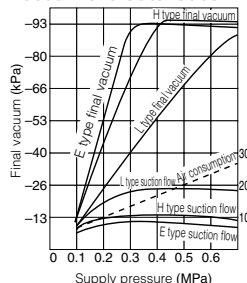

Flow characteristics

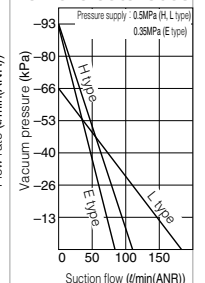

VUH05, VUL05, VMH05, VML05, VCH05, VCL05

Vacuum characteristics

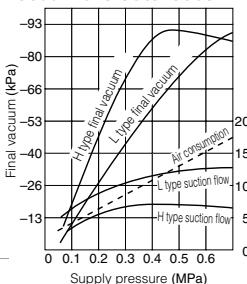

Flow characteristics

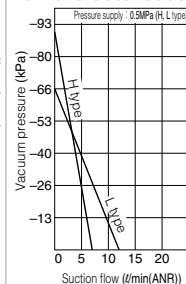

VUH07, VUL07, VUE07

Vacuum characteristics

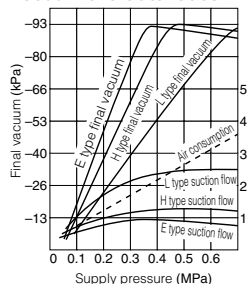

Flow characteristics

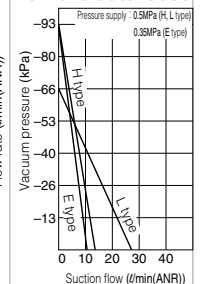



Vacuum Generator Series

Vacuum Generator VH,VS,VU,VUM,VB,VM,VC,VY

VACUUM GENERATOR

Characteristics

Vacuum arrival time (Supply pressure H and L types: 0.5MPa, E type: 0.3 to 0.5MPa)

※ The following graphs is for reference only since the values vary according to the piping arrangement.

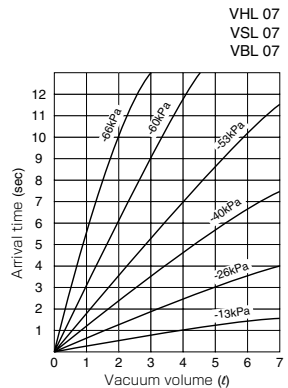
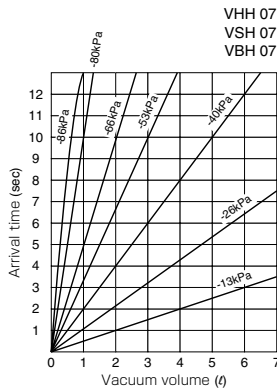
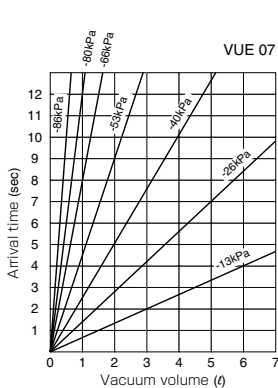
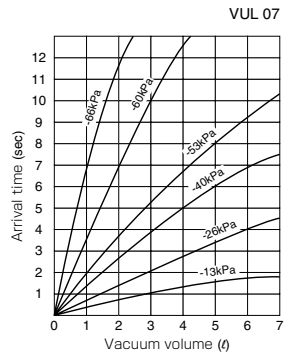
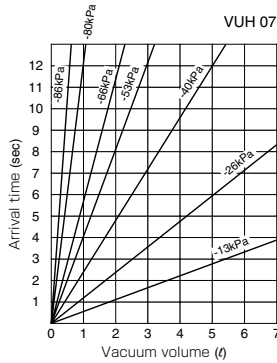
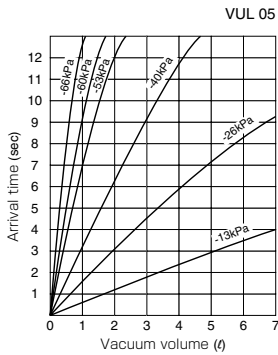
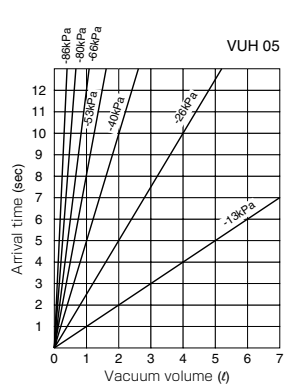
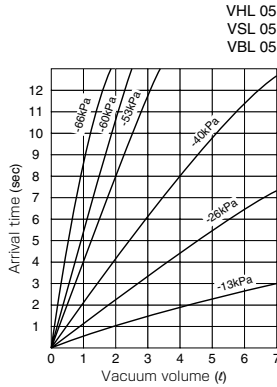
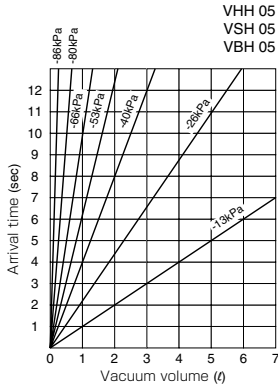

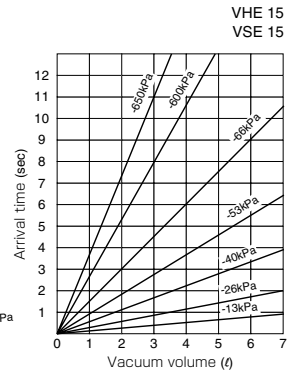
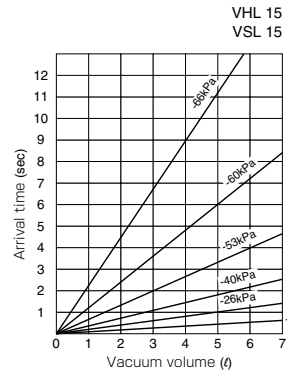
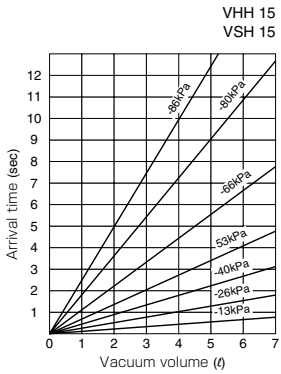
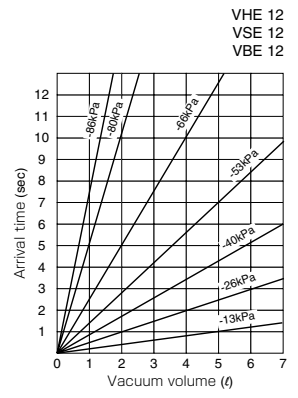
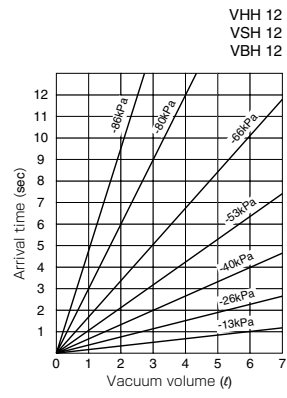
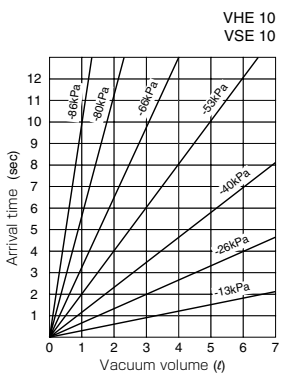
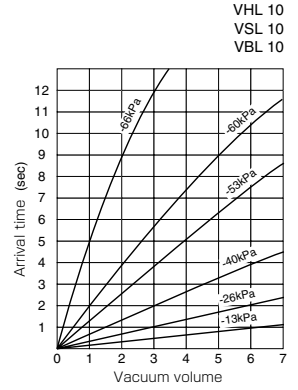
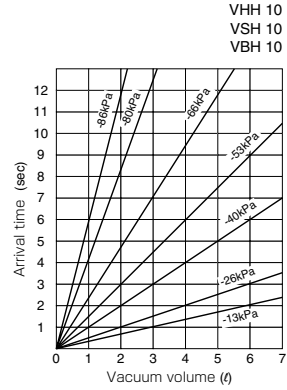
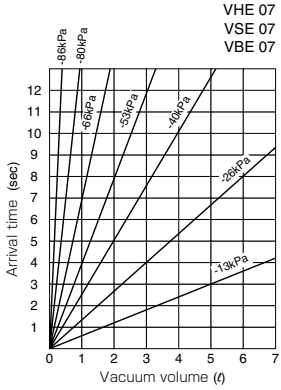

Pipe Type (Nozzle bore: $\phi 0.3 / 0.4 / 0.5 / 0.7\text{mm}$) / Box Type (Nozzle bore: $\phi 0.5 / 0.7 / 1.0 / 1.2\text{mm}$) Union Type

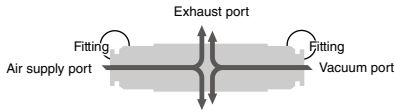

Type	Page to refer	Air supply port	Vacuum port	
			4mm	6mm
VU Pipe Type Union Straight (Silencer vent)	74	4mm	●	●
		6mm	●	●

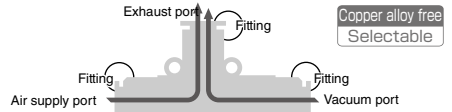

Type	Page to refer	Air supply port	Vacuum port		Exhaust port
			4mm	6mm	
VU Pipe Type Union Straight Tube Exhaust	75	4mm	●	●	6mm
		6mm	●	●	

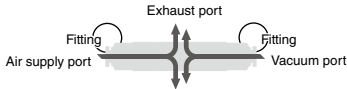

Type	Page to refer	Air supply port	Vacuum port		
			1.8mm	3mm	4mm
VUM Pipe Type Union Straight (vent)	77	3mm	●	●	●
		4mm	●	●	●

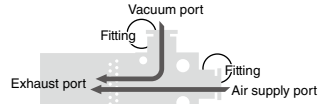

Type	Page to refer	Air supply port	Vacuum port	
			4mm	6mm
VB Box Type Union Vacuum Switch	86	4mm	●	
		6mm		●

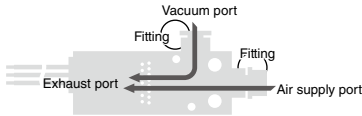

Type	Page to refer	Air supply port	Vacuum port	
			4mm	6mm
VB Box Type Union Vacuum Switch	86	4mm	●	
		6mm		●

Pipe Type Adaptor (Nozzle bore: $\phi 0.5 / 0.7\text{mm}$)

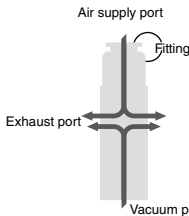

Type	Page to refer	Air supply port	
		4mm	6mm
VU Pipe Type Adaptor (Silencer vent)	76	●	●

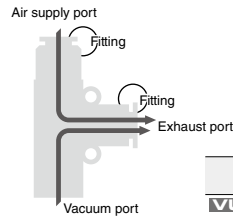

Type	Page to refer	Air supply port	
		4mm	6mm
VU Pipe Type Adaptor Tube Exhaust	76	●	●

VACUUM GENERATOR
EXTERNAL VACUUM CONTROLLER
VACUUM PAD
VACUUM ACCESSORIES

64
VH-VS
VU
VUM
VY
VB
VM-VC
VRL
VG
VK
VJ
VX
VQ
VZ
VN

How to insert and disconnect

1. How to insert and disconnect tubes

① Tube insertion

Insert a tube into Push-In Fitting of the vacuum generator up to the tube end. Lock-claws bite the tube to fix it and the elastic sleeve seals around the tube. Refer to "2. Instructions for Tube Insertion" under "Common Safety Instructions for Fittings" .

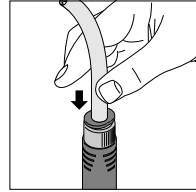

② Tube disconnection

The tube is disconnected by pushing release-ring to release Lock-claws. Make sure to stop air supply before the tube disconnection.

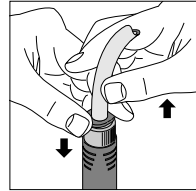

2. How to tighten thread

① Tightening thread

There are two ways to fix vacuum generators. One is tightening a hexagonal-column by a proper spanner, and the other is fixing with M4 thread at the fixing holes which is adopted to VB and VUSM.

Refer to the outer dimensional drawings of the hole pitch.

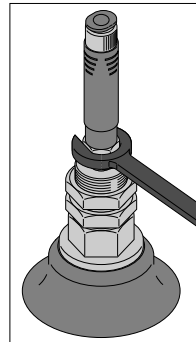

Applicable Tube and Related Products

Vacuum Tube (Piping products catalog Vacuum Pads

P.612)

■ Ultra-soft tube is suitable for vacuum products or actuators.

- Vacuum Pad Standard Series . . . P.428
- Vacuum Pad Sponge Series . . . P.468
- Vacuum Pad Bellows Series . . . P.488
- Vacuum Pad Multi-Bellows Series P.508
- Vacuum Pad Oval Series P.526
- Vacuum Pad Soft Series P.550
- Vacuum Pad Soft Bellows Series · P.578
- Vacuum Pad Skidproof Series . . · P.604
- Vacuum Pad Ultrathin Series . . . P.624
- Vacuum Pad Mark-free Series . . · P.642
- Vacuum Pad Long Stroke Series · P.658

VB Box Type Union (Silencer vent)



RoHS compliant

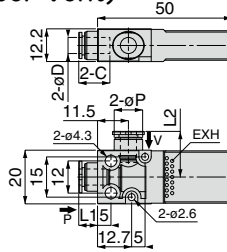

Unit : mm

Model code	Tube O.D. øD	øP	C	L1	L2	Nozzle bore (mm)	Operating pressure (MPa)	Final vacuum (-kPa)	Suction flow (l/min(ANR))	Air consumption (l/min(ANR))	Weight (g)	CAD file name
VBH05-44P	4	9	11	6.6	16.6	0.5	0.5	90	7	11.5	18	VB_05-44P
VBH07-66P	6	10.5	11.6	7	17	0.7		13	23	18.5	VB_-66P	
VBH10-66P						1		28	46			
VBH12-66P						1.2	38	70				
VBL05-44P	4	9	11	6.6	16.6	0.5	0.45	66	12	11.5	18	VB_05-44P
VBL07-66P	6	10.5	11.6	7	17	0.7		26	23	18.5	VB_-66P	
VBL10-66P						1		42	46			
VBE07-66P						0.7	10.5	17	18.5			VB_-66P
VBE10-66P	1	21	34									
VBE12-66P	1.2	27	47									

VB Box Type Union Vacuum Switch



RoHS compliant

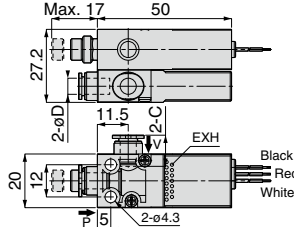

Unit : mm

Model code	Tube O.D. øD	C	Nozzle bore (mm)	Operating pressure (MPa)	Final vacuum (-kPa)	Suction flow (l/min(ANR))	Air consumption (l/min(ANR))	Weight (g)	CAD file name
VBH05-44S	4	11	0.5	0.5	90	7	11.5	46.5	VB_05-44S
VBH07-66S	6	11.6	0.7		13	23	46	VB_-66S	
VBH10-66S			1		28	46	47		
VBH12-66S			1.2	38	70	47.5			
VBL05-44S	4	11	0.5	0.45	66	12	11.5	46.5	VB_05-44S
VBL07-66S	6	11.6	0.7		26	23	48	VB_-66S	
VBL10-66S			1		42	46	46.5		
VBE07-66S			0.7	10.5	17	48.5	VB_-66S		
VBE10-66S	1	21	34						
VBE12-66S	1.2	27	47						

※ Lead wire White: Common
Red: Normally closed
Black: Normally open



VACUUM GENERATOR
EXTERNAL VACUUM CONTROLLER
VACUUM PAD
VACUUM ACCESSORIES

86

VH-VS

VU

VUM

VY

VB

VM-VC

VRL

VG

VK

VJ

VX

VQ

VZ

VN

Vacuum Generator Series

Vacuum Generator VH,VS,VU,VUM,VB,VM,VC,VY

VACUUM GENERATOR

VUSM Mechanical Vacuum Switch

RoHS compliant

CAD
2D & 3D

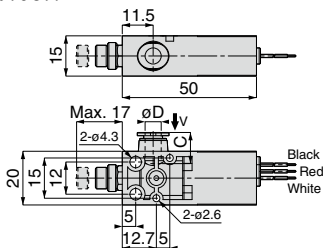

Unit : mm

Model code	Tube O.D. øD	C	Weight (g)	CAD file name
VUSM10-4	4	11	29	VUSM10-4
VUSM10-6	6	11.6	29	VUSM10-6

※ Lead wire White: Common
Red: Normally closed
Black: Normally open

Replacement

Element A model code	Element B model code
SEE0602	VGED-G

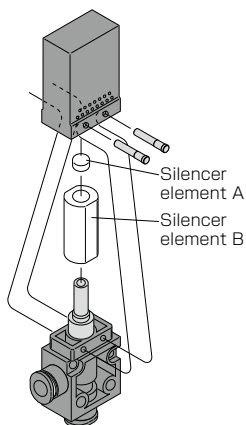

87

VH - VS

VU

VUM

VY

VB

VM - VC

CAD
2D & 3D

CAD data is available at PISCO website.



SAFETY Instructions

This safety instructions aim to prevent personal injury and damage to properties by requiring proper use of PISCO products.

Be certain to follow ISO 4414 and JIS B 8370

ISO 4414 : Pneumatic fluid power...Recommendations for the application of equipment to transmission and control systems.

JIS B 8370 : General rules and safety requirements for systems and their components.

This safety instructions is classified into "Danger", "Warning" and "Caution" depending on the degree of danger or damages caused by improper use of PISCO products.



Danger

Hazardous conditions. It can cause death or serious personal injury.



Warning

Hazardous conditions depending on usages. Improper use of PISCO products can cause death or serious personal injury.



Caution

Hazardous conditions depending on usages. Improper use of PISCO products can cause personal injury or damages to properties.



Warning

1. Selection of pneumatic products

- ① A user who is a pneumatic system designer or has sufficient experience and technical expertise should select PISCO products.
- ② Due to wide variety of operating conditions and applications for PISCO products, carry out the analysis and evaluation on PISCO products. The pneumatic system designer is solely responsible for assuring that the user's requirements are met and that the application presents no health or safety hazards. All designers are required to fully understand the specifications of PISCO products and constitute all systems based on the latest catalog or information, considering any malfunctions.

2. Handle the pneumatic equipment with enough knowledge and experience

- ① Improper use of compressed air is dangerous. Assembly, operation and maintenance of machines using pneumatic equipment should be conducted by a person with enough knowledge and experience.

3. Do not operate machine / equipment or remove pneumatic equipment until safety is confirmed.

- ① Make sure that preventive measures against falling work-pieces or sudden movements of machine are completed before inspection or maintenance of these machine.
- ② Make sure the above preventive measures are completed. A compressed air supply and the power supply to the machine must be off, and also the compressed air in the systems must be exhausted.
- ③ Restart the machines with care after ensuring to take all preventive measures against sudden movements.

Disclaimer

1. PISCO does not take any responsibility for any incidental or indirect loss, such as production line stop, interruption of business, loss of benefits, personal injury, etc., caused by any failure on use or application of PISCO products.
2. PISCO does not take any responsibility for any loss caused by natural disasters, fires not related to PISCO products, acts by third parties, and intentional or accidental damages of PISCO products due to incorrect usage.
3. PISCO does not take any responsibility for any loss caused by improper usage of PISCO products such as exceeding the specification limit or not following the usage the published instructions and catalog allow.
4. PISCO does not take any responsibility for any loss caused by remodeling of PISCO products, or by combinational use with non-PISCO products and other software systems.
5. The damages caused by the defect of Pisco products shall be covered but limited to the full amount of the PISCO products paid by the customer.



SAFETY INSTRUCTION MANUAL

PISCO products are designed and manufactured for use in general industrial machines. Be sure to read and follow the instructions below.

⚠ Danger

1. Do not use PISCO products for the following applications.
 - ① Equipment used for maintaining / handling human life and body.
 - ② Equipment used for moving / transporting human.
 - ③ Equipment specifically used for safety purposes.

⚠ Warning

1. Do not use PISCO products under the following conditions.
 - ① Beyond the specifications or conditions stated in the catalog, or the instructions.
 - ② Under the direct sunlight or outdoors.
 - ③ Excessive vibrations and impacts.
 - ④ Exposure / adhere to corrosive gas, inflammable gas, chemicals, seawater, water and vapor. *
 - * Some products can be used under the condition above(④), refer to the details of specification and condition of each product.
2. Do not disassemble or modify PISCO products, which affect the performance, function, and basic structure of the product.
3. Turn off the power supply, stop the air supply to PISCO products, and make sure there is no residual air pressure in the pipes before maintenance and inspection.
4. Do not touch the release-ring of push-in fitting when there is a working pressure. The lock may be released by the physical contact, and tube may fly out or slip out.
5. Frequent switchover of compressed air may generate heat, and there is a risk of causing burn injury.
6. Avoid any load on PISCO products, such as a tensile strength, twisting and bending. Otherwise, there is a risk of causing damage to the products.
7. As for applications where threads or tubes swing / rotate, use Rotary Joints, High Rotary Joints or Multi-Circuit Rotary Block only. The other PISCO products can be damaged in these applications.
8. Use only Die Temperature Control Fitting Series, Tube Fitting Stainless SUS316 Series, Tube Fitting Stainless SUS316 Compression Fitting Series or Tube Fitting Brass Series under the condition of over 60°C (140° F) water or thermal oil. Other PISCO products can be damaged by heat and hydrolysis under the condition above.
9. As for the condition required to dissipate static electricity or provide an antistatic performance, use EG series fitting and antistatic products only, and do not use other PISCO products. There is a risk that static electricity can cause system defects or failures.
10. Use only Fittings with a characteristic of spatter-proof such as Anti-spatter or Brass series in a place where flame and weld spatter is produced. There is a risk of causing fire by sparks.
11. Turn off the power supply to PISCO products, and make sure there is no residual air pressure in the pipes and equipment before maintenance. Follow the instructions below in order to ensure safety.
 - ① Make sure the safety of all systems related to PISCO products before maintenance.
 - ② Restart of operation after maintenance shall be proceeded with care after ensuring safety of the system by preventive measures against unexpected movements of machines and devices where pneumatic equipment is used.
 - ③ Keep enough space for maintenance when designing a circuit.
12. Take safety measures such as providing a protection cover if there is a risk of causing damages or fires on machine / facilities by a fluid leakage.

⚠ Caution

1. Remove dusts or drain before piping. They may get into the peripheral machine / facilities and cause malfunction.
2. When inserting an ultra-soft tube into push-in fitting, make sure to place an Insert Ring into the tube edge. There is a risk of causing the escape of tube and a fluid leakage without using an Insert Ring.
3. The product incorporating NBR as seal rubber material has a risk of malfunction caused by ozone crack. Ozone exists in high concentrations in static elimination air, clean-room, and near the high-voltage motors, etc. As a countermeasure, material change from NBR to HNBR or FKM is necessary. Consult with PISCO for more information.
4. Special option "Oil-free" products may cause a very small amount of a fluid leakage. When a fluid medium is liquid or the products are required to be used in harsh environments, contact us for further information.
5. In case of using non-PISCO brand tubes, make sure the tolerance of the outer tube diameter is within the limits of Table 1.

● Table 1. Tube O.D. Tolerance

mm size	Nylon tube	Polyurethane tube	inch size	Nylon tube	Polyurethane tube
ø1.8mm	—	± 0.05mm	ø1/8	± 0.1mm	± 0.15mm
ø3mm	—	± 0.15mm	ø5/32	± 0.1mm	± 0.15mm
ø4mm	± 0.1mm	± 0.15mm	ø3/16	± 0.1mm	± 0.15mm
ø6mm	± 0.1mm	± 0.15mm	ø1/4	± 0.1mm	± 0.15mm
ø8mm	± 0.1mm	± 0.15mm	ø5/16	± 0.1mm	± 0.15mm
ø10mm	± 0.1mm	± 0.15mm	ø3/8	± 0.1mm	± 0.15mm
ø12mm	± 0.1mm	± 0.15mm	ø1/2	± 0.1mm	± 0.15mm
ø16mm	± 0.1mm	± 0.15mm	ø5/8	± 0.1mm	± 0.15mm

6. Instructions for Tube Insertion

- ① Make sure that the cut end surface of the tube is at right angle without a scratch on the surface and deformations.
- ② When inserting a tube, the tube needs to be inserted fully into the push-in fitting until the tubing edge touches the tube end of the fitting as shown in the figure below. Otherwise, there is a risk of leakage.

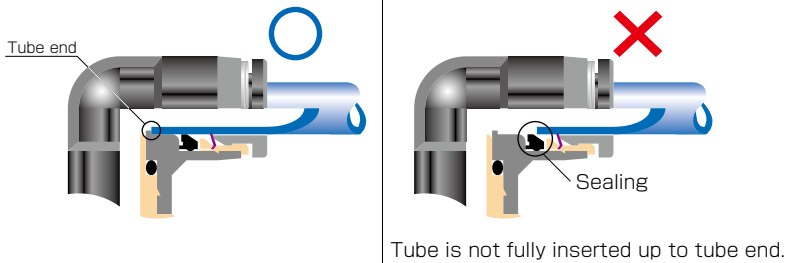

- ③ After inserting the tube, make sure it is inserted properly and not to be disconnected by pulling it moderately.
- ※ When inserting tubes, Lock-claws may be hardly visible in the hole, observed from the front face of the release-ring. But it does not mean the tube will surely escape. Major causes of the tube escape are the followings;
 - ① Shear drop of the lock-claws edge
 - ② The problem of tube diameter (usually small)
 Therefore, follow the above instructions from ① to ③, even lock-claws is hardly visible.

7. Instructions for Tube Disconnection

- ① Make sure there is no air pressure inside of the tube, before disconnecting it.
- ② Push the release-ring of the push-in fitting evenly and deeply enough to pull out the tube toward oneself. By insufficient pushing of the release-ring, the tube may not be pulled out or damaged by scratch, and tube shavings may remain inside of the fitting, which may cause the leakage later.

8. Instructions for Installing a fitting

- ① When installing a fitting, use proper tools to tighten a hexagonal-column or an inner hexagonal socket. When inserting a hex key into the inner hexagonal socket of the fitting, be careful so that the tool does not touch lock-claws. The deformation of lock-claws may result in a poor performance of systems or an escape of the tube.
- ② Refer to Table 2 which shows the recommended tightening torque. Do not exceed these limits to tighten a thread. Excessive tightening may break the thread part or deform the gasket and cause a fluid leakage. Tightening thread with tightening torque lower than these limits may cause a loosened thread or a fluid leakage.
- ③ Adjust the tube direction while tightening thread within these limits, since some PISCO products are not rotatable after the installation.

● Table 2: Recommended tightening torque / Sealock color / Gasket materials

Thread type	Thread size	Tightening torque	Sealock color	Gasket materials
Metric thread	M3 × 0.5	0.7N·m	—	SUS304 NBR
	M5 × 0.8	1.0 ~ 1.5N·m		
	M6 × 1	2 ~ 2.7N·m		
	M3 × 0.5	0.5 ~ 0.6N·m		POM
	M5 × 0.8	1 ~ 1.5N·m		
	M6 × 0.75	0.8 ~ 1N·m		
Taper pipe thread	M8 × 0.75	1 ~ 2N·m	White	—
	R1/8	7 ~ 9N·m		
	R1/4	12 ~ 14N·m		
	R3/8	22 ~ 24N·m		
Unified thread	R1/2	28 ~ 30N·m	—	SUS304, NBR
	No.10-32UNF	1.0 ~ 1.5N·m		
National pipe thread taper	1/16-27NPT	7 ~ 9N·m	White	—
	1/8-27NPT	7 ~ 9N·m		
	1/4-18NPT	12 ~ 14N·m		
	3/8-18NPT	22 ~ 24N·m		
	1/2-14NPT	28 ~ 30N·m		

※ These values may differ for some products. Refer to each specification as well.

9. Instructions for removing a fitting

- ① When removing a fitting, use proper tools to loosen a hexagonal-column or an inner hex bolt.
- ② Remove the sealant stuck on the mating equipment. The remained sealant may get into the peripheral equipment and cause malfunctions.

10. Arrange piping avoiding any load on fittings and tubes such as twist, tensile, moment load, shaking and physical impact. These may cause damages to fittings, tube deformations, bursting and the escape of tubes.



Common Safety Instructions for Vacuum Series

Before selecting or using PISCO products, read the following instructions. Read the detailed instructions for individual series.

Warning

1. If there is a risk of dropping work-pieces during vacuum suction, take a safety measure against the falling of them.
2. Avoid supplying more than 0.1MPa pressure constantly in a vacuum circuit. Since vacuum generators are not explosive-proof, there is a risk of damaging the products.
3. Pay attention to drop of vacuum pressure caused by problems of the supplied air or the power supply. Decrease of suction force may lead to a danger of falling work-piece so that safety measure against the falling of them is necessary.
4. When more than 2 vacuum pads are plumbed on a single ejector and one of them has a suction problem such as vacuum leak, there is a risk of releasing work-pieces from the other pad due to the drop of the vacuum pressure.
5. Do not use in the way by which exhaust port is blocked or exhaust resistance is increased. Otherwise, there is a risk of no vacuum generation or a drop of the vacuum pressure.
6. Do not use the product in the circumstance of corrosive gas, inflammable gas, explosive gas, chemicals, seawater and vapor or do not expose the product to those. Never allow the product to suck those things.
7. Provide a protective cover on the products when it is exposed to sunlight.
8. Carry out clogging check for silencer element in an ejector and a vacuum filter periodically. Clogged element will be a cause to impair the performance or a cause of troubles.
9. Before replacing the element, thoroughly read and understand the method of filter replacement in the catalog.
10. Make sure the correct port of the vacuum generator by this catalog or marking on the products when plumbing. Wrong plumbing can be a risk to damage the product.
11. Supply clean air without sludge or dusts to an ejector. Do not lubricate by a lubricator. There is a risk of malfunction or performance impairing by impurities and oil contained in the compressed air.
12. Do not apply extreme tension, twist or bending forces on a lead wire. Otherwise, it may cause a wire breaking.
13. Locknut needs to be tightened firmly by hand. Do not use any tool to tighten. In case of using tools to tighten the locknut, it may damage the locknut or the product. Inadequate tightening may loosen the locknut and the initial setting can be changed.
14. Do not force the product to rotate or swing even its resin body is rotatable. It may cause damage to the product and a fluid leakage.
15. Do not supply an air pressure or a dry air to the products over the necessary amount. There is a risk of deteriorating rubber materials and malfunction due to oil.
16. Keep the product away from water, oil drops or dusts. These may cause malfunction. Take a proper measure to protect the product before the operation.

17. Do not use the product in the environment of inflammable or explosive gas / fluid. It can cause a fire or an explosion hazard.
18. Do not use the product in the circumstance of corrosive gas, inflammable gas, explosive gas, chemicals, seawater and vapor or do not expose the product to those. Otherwise, it may be a cause of malfunction.
19. Do not clean or paint the products by water or a solvent.

⚠ Caution

1. Operating pressure range in the catalog is the values during ejector operation. Secure the described value of the supplied air, taking a drop of the pressure into consideration. Insufficient pressure, which does not satisfy the spec, may cause abnormal noise, unstable performance and may negatively affect sensors, bringing troubles at last.
2. Effective cross-section area of the air supply side needs to be three times as large as effective cross-section area of the nozzle bore. When arranging piping or selecting PISCO products, secure required effective cross-section area. Insufficient supply pressure may be a cause to impair performance.
3. A Shorter distance of plumbing with a wider bore is preferable at vacuum system side. A long plumbing with a small bore may result in slow response time at the time of releasing work-piece as well as in failure to secure adequate suction flow rate.
4. Plumb a vacuum switch and an ejector with vacuum switch at the end of vacuum system as much as possible. A long distance between a vacuum switch and a vacuum system end may increase plumbing resistance which may lead to a high vacuum level at the sensor even when no suctioning and a malfunction of vacuum switch. Make sure to evaluate the products in an actual system.
5. Refer to "4. Instructions for Installing a fitting" and "5. Instructions for Removing a fitting" under "Common Safety Instructions for Fittings" , when installing or removing Fittings.
6. Refer to "Common Safety Instructions for Pressure Sensors" and "Detailed Safety Instructions" for the handling of digital vacuum switch sensor.
7. Refer to "Common Safety Instructions for Mechanical Vacuum Sensor" for the handling of mechanical vacuum switch.
8. The material of plastic filter cover for VG, VK, VJ, VZ and VX series is PCTG. Avoid the adherence of Chemicals below to the products, and do not use them under those chemical environments.

● Table Chemical Name

Chemical Name
Thinner
Carbon tetrachloride
Chloroform
Acetate
Aniline
Cyclohexane
Trichloroethylene
Sulfuric acid
Lactic acid
Water soluble cutting oil (alkaline)

* There are more chemicals which should be avoided. Contact us for the use under chemical circumstance.

VACUUM GENERATOR
EXTERNAL VACUUM CONTROLLER
VACUUM PAD
VACUUM ACCESSORIES
48
VH-VS
VU
VUM
VY
VB
VM-VC
VRL
VG
VK
VJ
VX
VQ
VZ
VN

9. The material of plastic filter cover for VQ and VFU series is PA. Avoid the adherence of chemicals below to the products, and do not use them under those chemical environments.

● Table Chemical Name

Chemical Name
Methanol
Ethanol
Nitric acid
Sulfuric acid
Hydrochloric acid
Lactic acid
Acetone
Chloroform
Aniline
Trichloroethylene
Hydrogen peroxide

* There are more chemicals which should be avoided. Contact us for the use under chemical circumstance.

⚠ Common Safety Instructions for Mechanical Vacuum Switch

⚠ Warning

1. Do not use mechanical vacuum switch in the environment of inflammable or explosive gas / fluid. Since the products are not explosive-proof structure, use in such environment may cause a fire or an explosion.
2. Keep a mechanical vacuum switch away from water, oil drops or dusts which may cause malfunction. The product is not drip / dust proof structure.
3. Applying 0.5 MPa instantaneously to a mechanical vacuum switch does not affect on its performance, but do not apply more than 0.2 MPa constantly. It may cause damage to the switch.
4. Use a vacuum switch within the described pressure setting range in the specifications. There is a risk of malfunction by a hysteresis when the products are operated with the pressure beyond the range.
5. Make sure to turn off the power supply before plumbing mechanical vacuum switch. Pay special attention to lead wire colors to prevent a wrong wiring.

Mechanism of Vacuum Generator

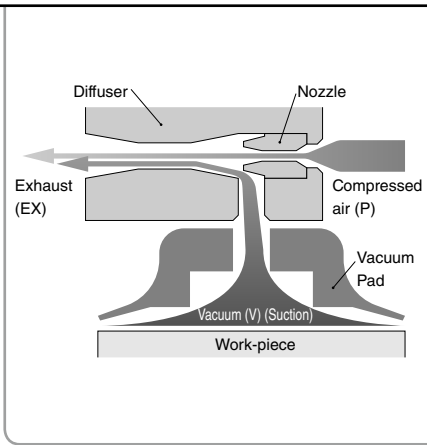

- An ejector (Vacuum generator) can generate the vacuum suction force by applying a compressed air to it. Its mechanism is explained in the left figure.
- Compressed air is squeezed and released to diffuser with high speed. The vacuum force is generated by a drop of pressure level due to a high-speed jet flow, and enables to convey a work-piece.
- An ejector consists of a nozzle and a diffuser in order to obtain a high degree of vacuum level by a high-speed jet flow. Final vacuum, exhaust airflow (suction flow) and air consumption are determined by the shapes and dimensions of these components.