

1 Compressed air supply only

2 No electricity

3 Long life

4 User friendly

5 Two models

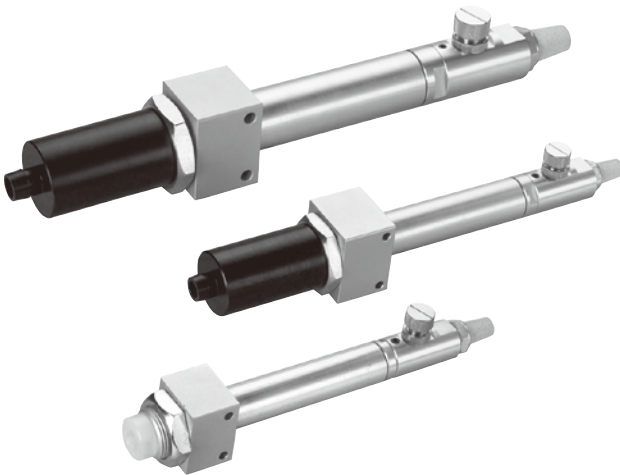

Features

- Jet out cooler air maximum 60°C(max. temp. drop) lower than the inlet air only by supplying compressed air.
- Uses the theory of vortex, no moving parts are used in the construction, hence long life sustainability.
- Does not require coolant or an electrical source, utilises the high speed flow of compressed air for generating cool air from hot air. Ideal for applications where rapid cooling is required, (ie) Spot Welding.
- Can produce consistent supply of cool air even when the supply in is 40 Degrees C. By changing air consumption you can simply change the cooling temperature.

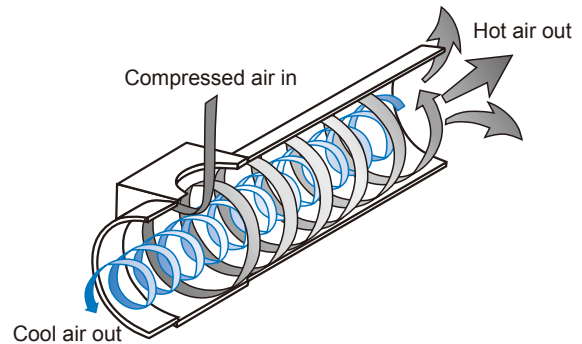

Order example

MJC — 150K — S — □

MODEL
MJC-150K
MJC-300K
MJC-450K
MJC-600K

ACCESSORY
Blank: Standard type
S: Silencer
Decrease 8-12dB
(Based on the flow rate)

PORT THREAD
Blank: Rc thread
G: G thread
NPT: NPT thread

Cool air adjustment

Temperature drop 60°C

- Rapid temperature drop.
- Panel mounting option available.
- Can be fitted with silencer on cold side, thus reducing noise.
- Can be piped on the hot side.

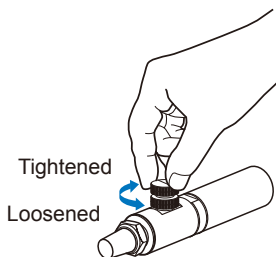

Adj. screw(up)
Adj. nut (down)

* When the adj. screw has set,
lock the adj. nut.

Specification

Model	Working pressure (MPa)	Max. temp. drop (°C)	Cool air out port	Weight (kg)
MJC-150K	0.3~0.7	60	Rc1/8	0.25
MJC-300K	0.3~0.7	60	Rc1/4	0.30
MJC-450K	0.3~0.7	60	Rc3/8	0.60
MJC-600K	0.3~0.7	60	Rc3/8	0.60

*The max. temp. drop is the difference in temp. between the input and the output.

Temperature drop of cool air

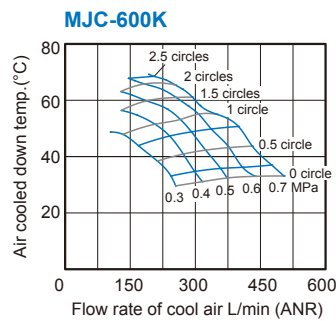
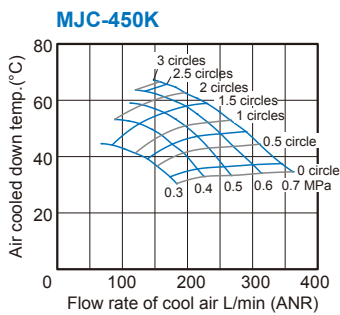
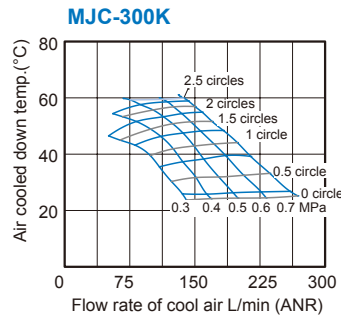
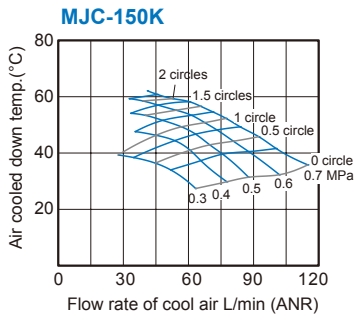

Graph description (MJC-150K)

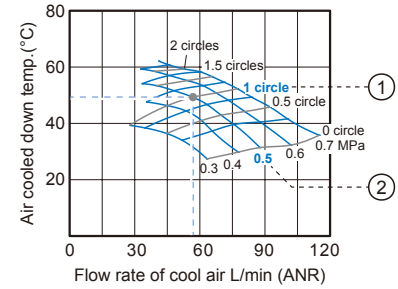

Cold air flow rate & temperature drop

1. One time of rotating the adjust screw from tightening condition.
2. Temperature drop is around 48°C under the condition of air pressure = 0.5 MPa and cold air flow rate = 58 L/min(ANR)

Cooling capacity * The heat quantity which is able to be absorbed (cooling).

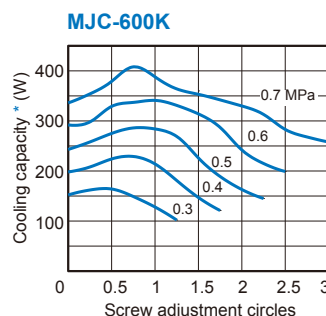
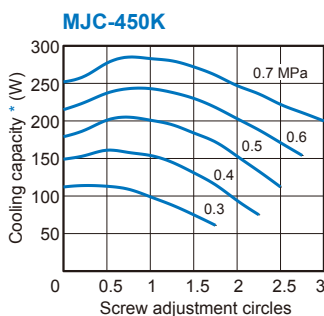
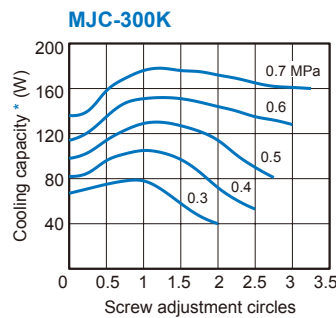
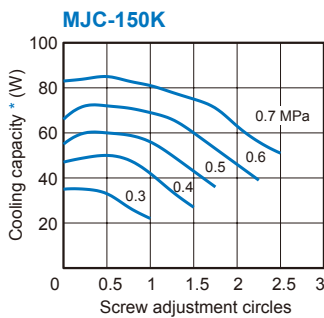

Air consumption

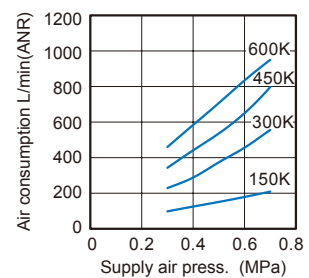

MJC-**K*

Silencer (option)

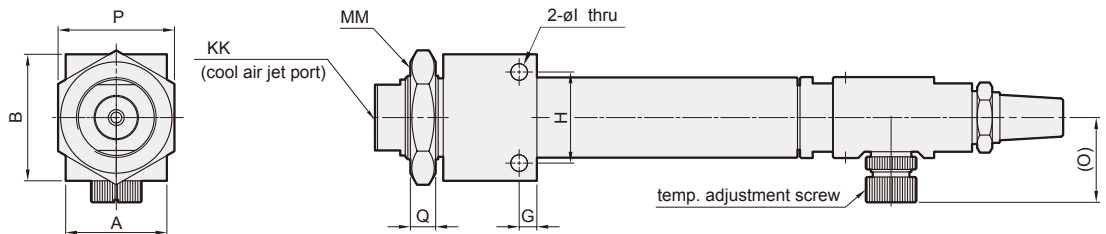
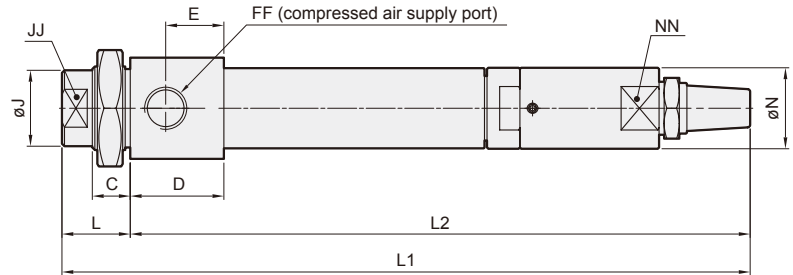
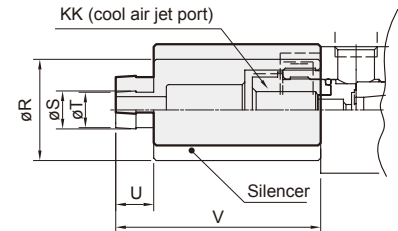

Code Model	A	B	C	D	E	FF	G	H	I	J	JJ	KK	L	L1	L2	MM	N	NN	O	P	Q	R	S	T	U	V
150K	30	35	13	24	15	Rc1/8	5	24	4.5	20	17	Rc1/8	21	198	177	M24×1.5	20	18	22	32	7	30	11	10	10	60
300K	35	40	15	28	17	Rc1/4	5	30	4.5	22	19	Rc1/4	23	204	181	M27×1.5	22	19	22	36	7	32	13	12	10	63
450K / 600K	40	50	15	37	23	Rc3/8	7	36	6.6	30	26	Rc3/8	27	272	245	M33×1.5	32	27	31	46	10	40	15	14	15	81

Application

Plastic machining cool

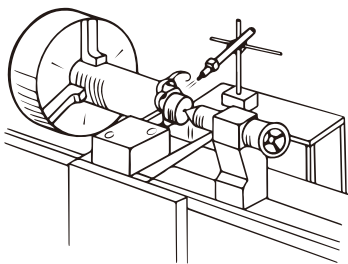

Spot welding cool

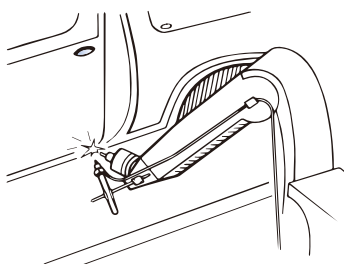

Monitoring camera case cool and dust-proof inside control box

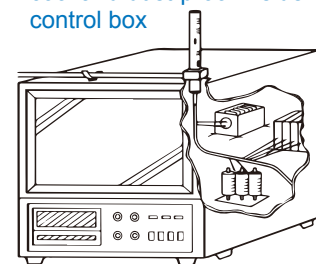

Wire cut harden

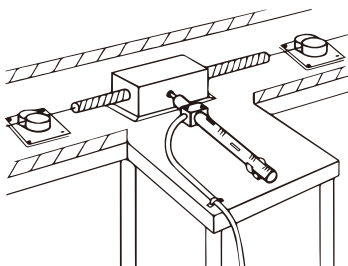

Adherent quick cool

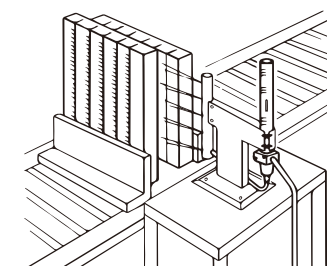

Welding quick cool

